

# KRAKOWITZER GmbH.

Schweissen. Schneiden. Gasetechnik.

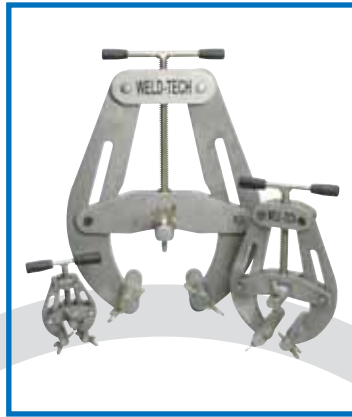

## Tools for Pipe Welding

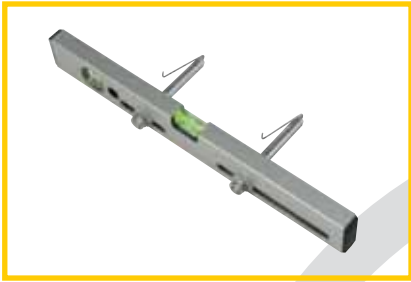
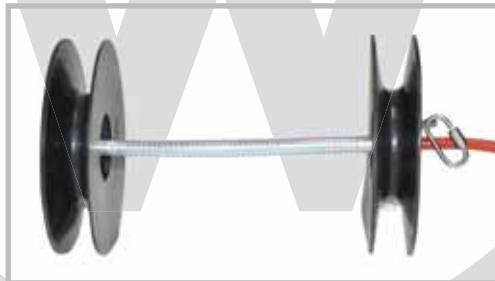

Slæ[, ã^!AÖ{ àP  
U^ã ò^!AÜdæ^A€  
l€€S^}ãã\*



V^|ÉI HÁED HÍ FFGH  
T æk~ã^O\|æ[, ã^!Éæ  
Y^ák, , Éiæ[, ã^!Éæ

# PF Clamp



**LIFETIME  
WARRANTY  
ON BROKEN PARTS**

The unique design of the PF Clamp gives an extremely strong clamp for fit-up of all types of pipes and fittings in both Carbon Steel and Stainless Steel.

All contact points of the clamp is stainless steel and the bolts are galvanized with a stainless steel ball-point to ensure perfect fit-up

Cat. No.	Range (inch)	Range (mm)	Weight (kg)	Weight (lbs)
PF13	1 - 3	25 - 80	1,10	2,20
PF26	2 - 6	50 - 170	3,20	6,40
PF614	6 - 14	150 - 360	8,20	16,00

Slæ[ , ã ^ \ / \ { à P  
U ^ ã q ^ \ / \ U d æ ^ A €  
I € € S ^ \ } à ã \*



V ^ \ E I H á G D H G Í F F G H  
T æ k ~ & \ O \ \ æ [ , ã ^ \ / \ æ  
Y ^ \ á k , , E i æ [ , ã ^ \ / \ æ

# WT Steel Clamp



**LIFETIME  
WARRANTY**  
ON BROKEN PARTS

This series of robust forged Steel Clamps is designed for Pipe to Pipe or Pipe to Fittings. The WT Steel Clamps are electro galvanized, and assure fast and effective clamping.

The Butterfly Screws are made with Stainless Steel Balls, this eliminates scratching of the object to be welded and corrosion will not occur.

The Clamp is made of sink forged steel. This gives enough clamping force to comply with the demands for all the pipe dimensions within the WT Steel Clamps range of 25-355 mm (1"-14").

Cat. No.	Range (inch)	Range (mm)	Weight (kg)	Weight (lbs)
SC13	1 - 3	26 - 76	1,5	3
SC25	2 - 5	51 - 127	3,1	6,2
SC47	4 - 7	102 - 177	3,3	6,6
SC59	5 - 9	127 - 228	6,9	13,8
SC1014	10 - 14	254 - 355	8,8	17,6

Slæ [ , ã ^ \ / \ { à P  
U ^ ã ò ^ \ / \ U d æ ^ F €  
I € € S ^ \ } å ã \*



V ^ \ / \ É I H á G D H G Í F F G H  
T æ k ^ - ã ^ \ / \ ð [ , ã ^ \ / \ Æ  
Y ^ \ / \ á k , , É i æ [ , ã ^ \ / \ Æ

# WT Clamp

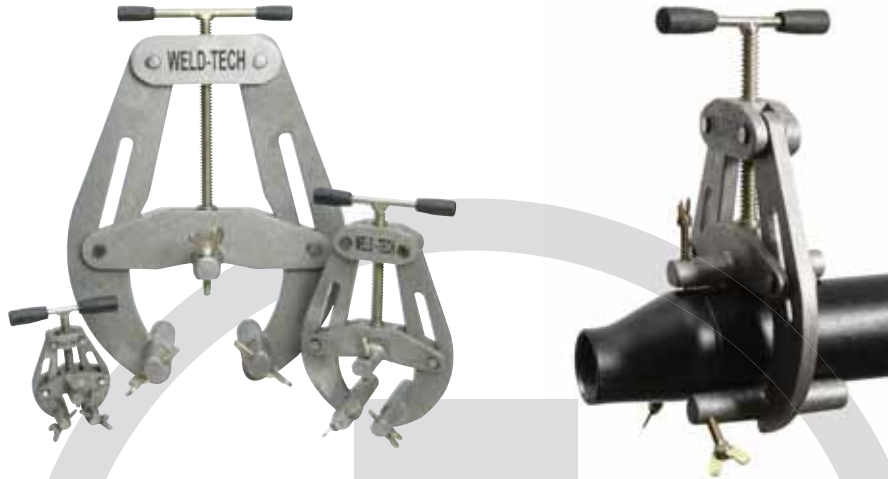

**LIFETIME  
WARRANTY  
ON BROKEN PARTS**

Due to its unique design, WT Clamp ensures that the clamping forces are evenly spread round the pipe to be welded, because the distance between clamping points are exactly the same. This is true for all pipe dimensions within the range of the WT Clamp (1 to 14 inches).

The adjusting screws have stainless steel balls at their ends. This eliminates the scratching of the objects to be welded, and no corrosion will occur.

The arms are made of casted aluminium which allows a clamping force to meet the requirements for all pipe dimensions within the range of the WT Clamp (27 – 355 mm) and with wall thickness of up to 15 mm.

WT Clamp can be used for the welding of all kinds of materials such as carbon steel, stainless steel, duplex, super duplex and titanium.

The welding of pipe to pipe and pipe to fittings are easily performed with WT Clamp.

Cat. No.	Range (inch)	Range (mm)	Weight (kg)	Weight (lbs)
WT125	1 - 2,5	27 - 64	0.75	1,50
WT26	2 - 6	60 - 168	2.60	5,20
WT612	6 - 14	168 - 355	7.50	15,00

Slæ [ , ã ^ | Å { à P  
U ^ ã ò ^ | Å d æ ^ Å €  
| € € S ^ { } å ã \*



V ^ | É | H á G D H G Í F F G H  
T æ ã K ~ & ^ O \ | æ [ , ã ^ | É æ  
Y ^ ã K , , É | æ [ , ã ^ | É æ

# Manual Pipe Clamps, single



Single chain clamp type 2500S is an easy tool for clamping pipe to pipe, pipe to bend, pipe to tee or pipe to flange. The low weight make it very easy to operate in the workshop and on site.

These clamps can adjust and align pipes with wall-thickness up to 1/2" (12 mm), and has a clamping force of 2500 kg.

The clamps can be used for several pipe dimensions, simply by removing the jack-bars. The jack-bars are made of stainless steel on all our clamps.

Type 2500S can be used for stainless steel, as only stainless steel is in contact with the pipe.

All clamps can be used for pipe dimensions from 5".

## Type 2500S (single)

Range	For stainless steel				For carbon steel			
	Cat. No.	No. jackbars	Weight (kg/lbs)		Cat. No.	No. jackbars	Weight (kg/lbs)	
5 - 12"	2500SS512	4	6,3	12,6	2500SM512	4	6,3	12,6
5 - 16"	2500SS516	5	7,3	14,6	2500SM516	4	6,7	13,4
5 - 20"	2500SS520	6	8,3	16,6	2500SM520	5	7,7	15,4
5 - 24"	2500SS524	7	9,1	18,2	2500SM524	6	8,5	17,0
5 - 32"	2500SS532	10	11,7	23,4	2500SM532	8	10,5	21,0
5 - 36"	2500SS536	11	12,8	25,6	2500SM536	9	11,5	23,0
5 - 42"	2500SS542	13	14,2	28,4	2500SM542	11	13,2	26,4
5 - 48"	2500SS548	14	16,1	32,2	2500SM548	13	15,4	30,8
5 - 54"	2500SS554	15	17,8	35,6	2500SM554	14	17,1	34,2
5 - 60"	2500SS560	16	19,5	39,0	2500SM560	15	18,8	37,6

# Manual Pipe Clamps, double

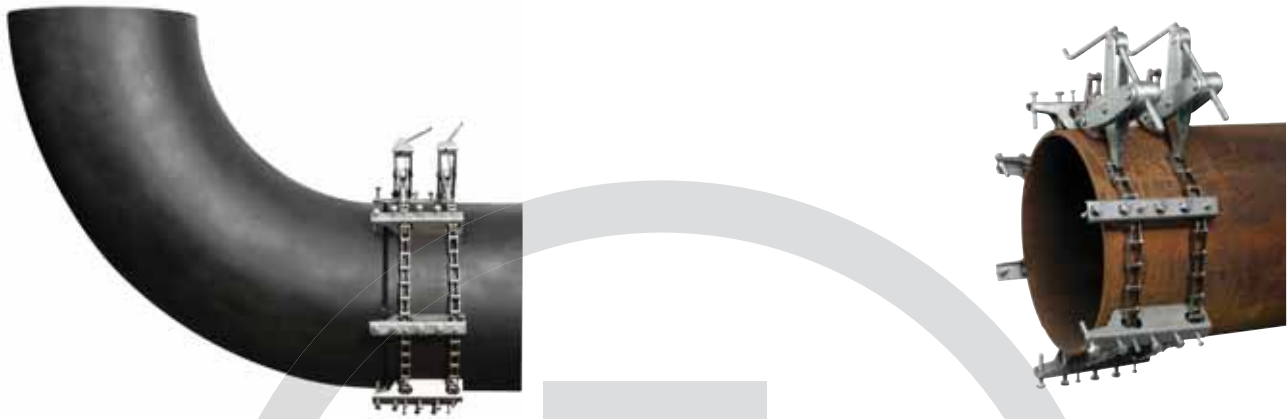

Double chain clamp type 2500D is an easy tool for clamping pipe to pipe, pipe to bend, pipe to tee or pipe to flange. The low weight make it very easy to operate in the workshop and on site.

These clamps can adjust and align pipes with wall-thickness up to 1/2" (12 mm), and has a clamping force of 2500 kg.

The clamps can be used for several pipe dimensions, simply by removing the jack-bars. The jack-bars are made of stainless steel on all our clamps.

Type 2500D can be used for stainless steel, as only stainless steel is in contact with the pipe.

All clamps can be used for pipe dimensions from 5".

## Type 2500D (double)

Range	For stainless steel			For carbon steel		
	Cat. No.	No. jackbars	Weight (kg/lbs)	Cat. No.	No. jackbars	Weight (kg/lbs)
5 - 12"	2500DS512	4	11,0 22,0	2500DM512	4	11,0 22,0
5 - 16"	2500DS516	5	12,6 25,2	2500DM516	4	11,8 23,6
5 - 20"	2500DS520	6	14,2 28,4	2500DM520	5	13,4 26,8
5 - 24"	2500DS524	7	15,4 30,8	2500DM524	6	14,6 29,2
5 - 32"	2500DS532	10	19,4 38,8	2500DM532	8	17,8 35,6
5 - 36"	2500DS536	11	20,5 41,0	2500DM536	9	18,9 37,8
5 - 42"	2500DS542	13	22,7 45,4	2500DM542	11	21,2 42,4
5 - 48"	2500DS548	14	24,1 48,2	2500DM548	13	23,3 46,6
5 - 54"	2500DS554	15	25,2 50,4	2500DM554	14	24,4 48,8
5 - 60"	2500DS560	16	27,0 54,0	2500DM560	15	26,2 52,4

# S200, D200 and DK200<sup>®</sup>



S200



D200

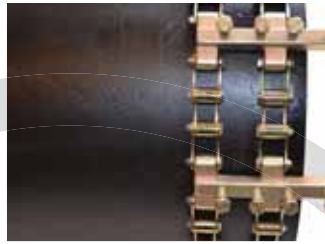

DK200



S200, D200 and DK200 is Chain Clamps that can adjust and align Pipes with a wall-thickness up to 12,7 mm. The Chain Clamps can always be modified to smaller or larger Pipe dimensions simply by changing the number of Chain Links and Jack-Bars.

		S200		D200		DK200	
Range	No. Jack-bars	Cat. No.	Weight kg	Cat. No.	Weight kg	Cat. No.	Weight kg
8 - 12"	6	S200812	9,3	D200812	18,6	DK200812	21,6
8 - 16"	7	S200816	10,5	D200816	20,1	DK200816	23,9
8 - 20"	9	S200820	12,9	D200820	23,1	DK200820	28,0
8 - 24"	11	S200824	15,3	D200824	26,1	DK200824	32,0
8 - 28"	13	S200828	17,7	D200828	29,1	DK200828	36,1
8 - 32"	14	S200832	18,8	D200832	30,6	DK200832	38,2
8 - 36"	16	S200836	21,2	D200836	33,6	DK200836	42,2
8 - 40"	18	S200840	23,6	D200840	36,6	DK200840	46,3
8 - 44"	19	S200844	24,8	D200844	38,1	DK200844	48,4
8 - 48"	21	S800848	27,2	D200848	41,2	DK800848	52,5
8 - 52"	23	S200852	29,5	D200852	44,2	DK200852	56,6
8 - 56"	25	S200856	31,9	D200856	47,2	DK200856	60,7
8 - 60"	26	S200860	33,1	D200860	48,7	DK200860	62,7

# S300, D300 and DK300<sup>®</sup>

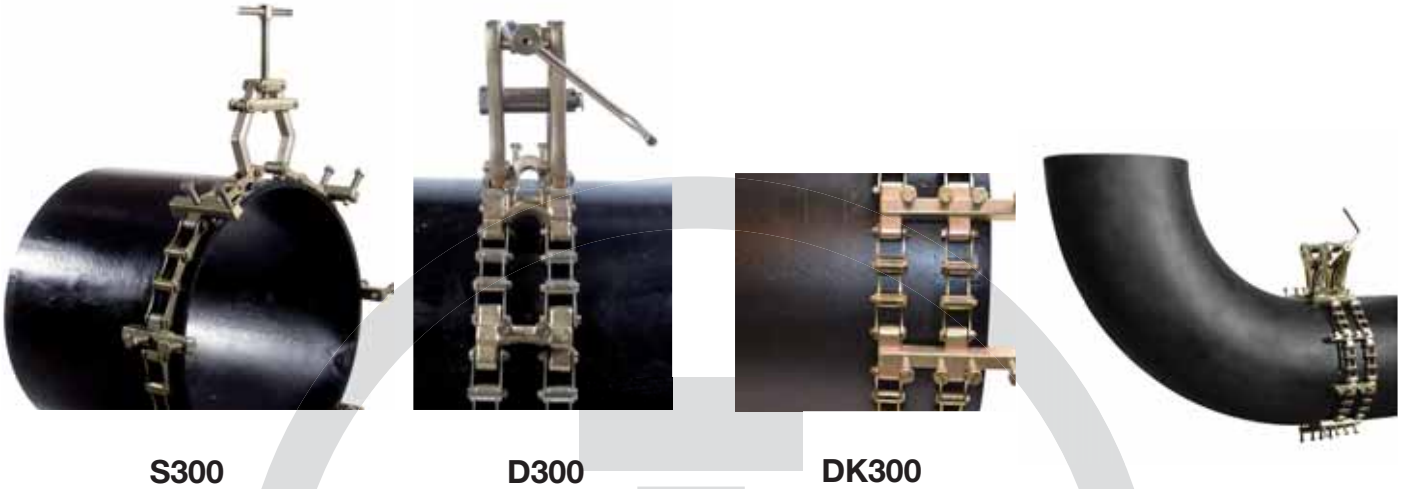

**S300**

**D300**

**DK300**

S300, D300 and DK300 is extremely powerful Chain Clamps that can adjust and align Pipes with a wall-thickness up to 20 mm. Easy to use and a guarantee for perfect clamping of the Pipes before welding.

		S300		D300		DK300	
Range	No. Jack-bars	Cat. No.	Weight kg	Cat. No.	Weight kg	Cat. No.	Weight kg
12 - 16"	5	S3001216	17,8	D3001216	39,4	DK3001216	43,4
12 - 20"	6	S3001220	20,5	D3001220	43,1	DK3001220	47,9
12 - 24"	7	S3001224	23,2	D3001224	46,7	DK3001224	52,3
12 - 28"	9	S3001228	28,5	D3001228	53,9	DK3001228	61,1
12 - 32"	10	S3001232	31,2	D3001232	57,6	DK3001232	65,6
12 - 36"	11	S3001236	33,8	D3001236	61,2	DK3001236	70,0
12 - 40"	12	S3001240	36,5	D3001240	64,8	DK3001240	74,4
12 - 44"	13	S3001244	48,2	D3001244	68,5	DK3001244	78,9
12 - 48"	15	S3001248	57,1	D3001248	75,7	DK3001248	87,7
12 - 52"	16	S3001252	60,7	D3001252	79,4	DK3001252	92,2
12 - 56"	17	S3001256	67,2	D3001256	82,9	DK3001256	96,5
12 - 60"	18	S3001260	69,8	D3001260	86,6	DK3001260	101,0



# IMC

Internal Manual Pipe Clamp (IMC) for welding flanges to pipes. The clamp has a range from 2,25" (56 mm) and up to 37" (940 mm).

# IMF

Internal Manual Flange Clamp suitable for clamping flanges to bends. Fast and easy tool.

Cat. no.	IMC56140	IMC85220	IMC120350	IMC180520	IMC400940	IMF56115	IMF85195	IMF120315	IMF180520
Range I.D. mm	56 - 140	85 - 220	120 - 350	180 - 520	400 - 940	56 - 115	85 - 195	120 - 315	180 - 520
Range I.D. inch	2,2 - 5,5	3,3 - 8,6	4,7 - 12,4	7,0 - 20,4	19,2 - 37,0	2,2 - 4,5	3,3 - 7,6	4,7 - 12,4	7,0 - 20,4
kg	1,35	4	12	27	46	1	3	10	24

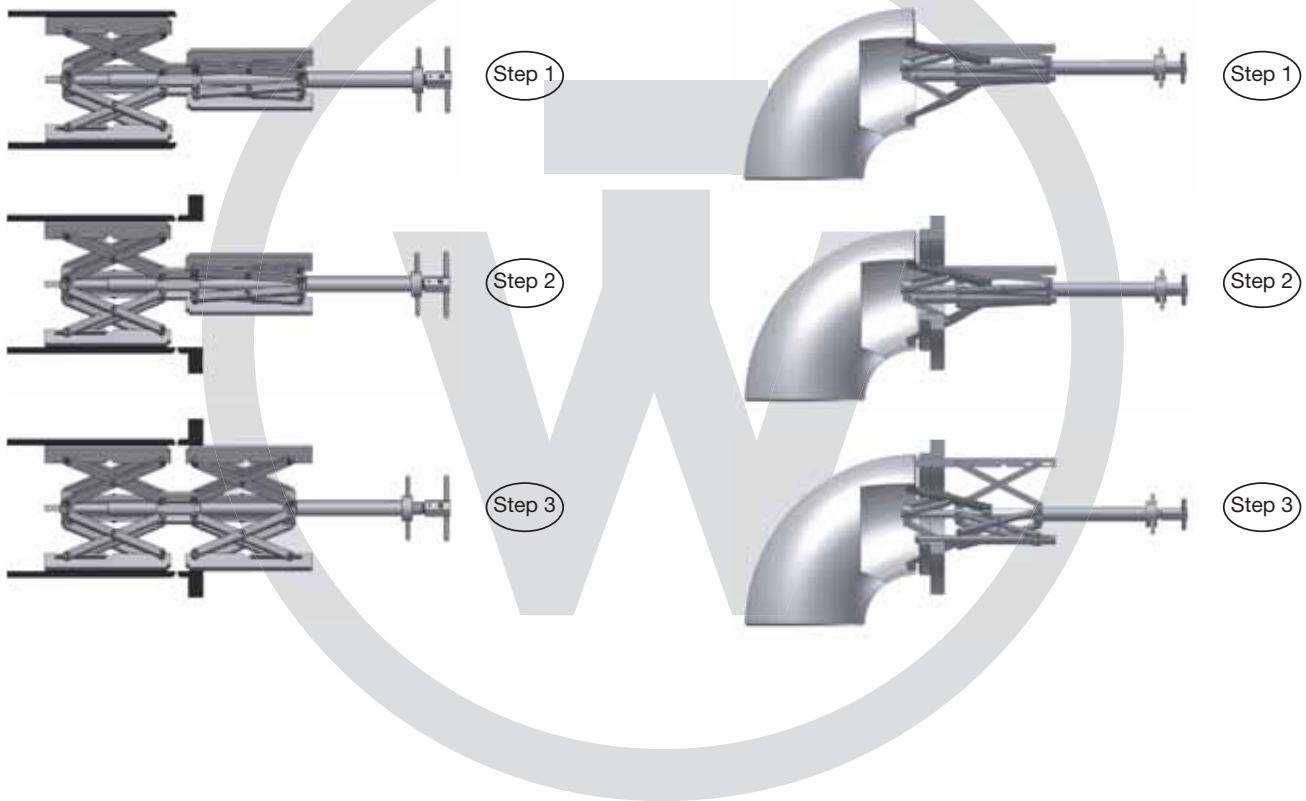

# Purge Flex

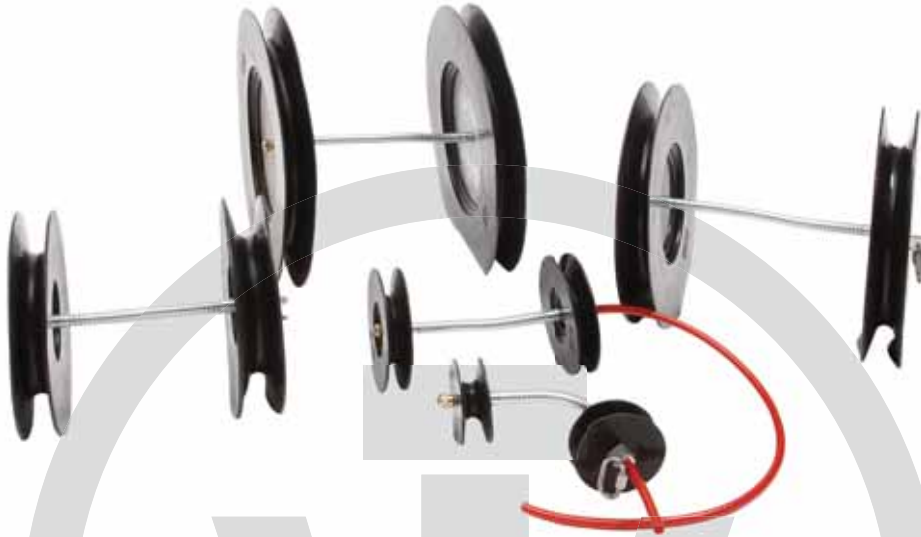

## Purge Flex Purging System:

Purge Flex, manufactured by WELD-TECH, is a double seal purging system that works in the ranges from 25 mm to 320 mm.

Purge Flex is easy to pull through pipes and bends without tilting. The design of the system also guarantee that at least one disc holds tight and this will reduce both purging time and inert gas use. Typical purge time of less than 2 minutes (for example an 8" pipe will purge to below 0,01% Oxygen in less than 2 minutes).

Going from the welding of one pipe dimension to another, you simply change the sealing discs on the basic unit. Basic units are available in 3 lengths, 120 mm, 150 mm and 200 mm. Each basic unit will fit all sizes of the sealing discs. Purge Flex sealing discs can also be used for all of WELD-TECH's other basic units, as well as from some other Manufacturers.

The Silicone Discs is temperature resistant up to 320°C.

Slæ[, ã^!Ã{ àP  
U^ã q^!A dæ ^F€  
l €l €S^ } äã \*



V^|ÉI HÁED HG Í FFGH  
T æãK ~&^O \læ [, ã^!Éæ  
Y^ãK , , Élæ [, ã^!Éæ

# Purge Flex

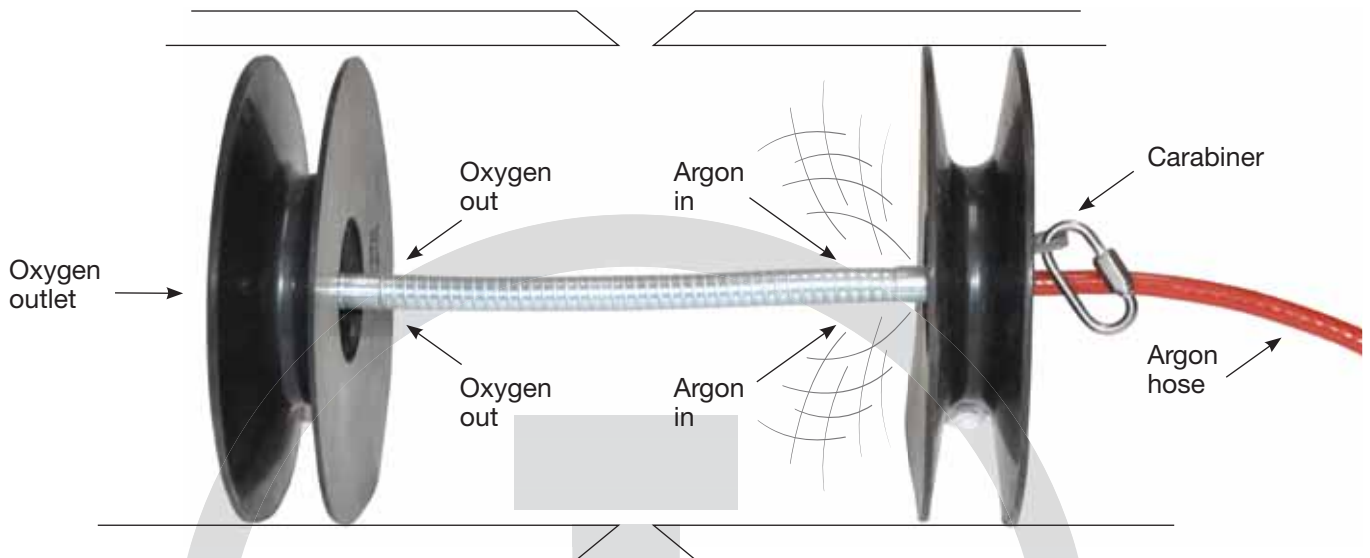

Purge Flex complete		
Cat. No.	DIA.	Range in mm
EZPF032	Ø32	25 - 31
EZPF043	Ø43	32 - 40
EZPF054	Ø54	41 - 50
EZPF064	Ø64	52 - 61
EZPF078	Ø78	62 - 74
EZPF090	Ø90	75 - 86
EZPF110	Ø110	85 - 100
EZPF120	Ø120	100 - 110
EZPF142	Ø142	120 - 135
EZPF160	Ø160	140 - 155
EZPF175	Ø175	150 - 165
EZPF210	Ø210	175 - 200
EZPF230	Ø230	195 - 215
EZPF270	Ø270	235 - 260
EZPF290	Ø290	255 - 280
EZPF310	Ø310	275 - 300
EZPF330	Ø330	290 - 320



Each set comes complete with Basic Unit, 10m Stainless Steel Wire and 10m Argon Hose including female coupling.

Slæ[, ã^!A{ àP  
U^ã q^!A dæ^A€  
l € €S^} äã \*



V^|ÉI HÁD HG Í FFGH  
T æk ~&O \læ[, ã^!Éæ  
Y^ák , , Éiæ[, ã^!Éæ

# Suitcase



Handy suitcase with everything needed to weld from 1" to 6".

**EZ-Purge Flex Suitcase**

Cat. No.	Range (mm)	Size	Weight (Kg)
EZPF-99	26 - 165	57x45x22 cm	8,5

# PM40



Oxygen monitor PM40 is designed for the low end of measuring the content of oxygen in the welding area. By measuring down to 40ppm is a perfect simple solution to ensure a perfect weld.

### Technical specifications:

Range: Down to 40ppm  
Battery: up to 20 hours before recharging is needed  
Accuracy: +/- 5ppm  
Display: Digital  
Sensor: Thermo-electric

### Advantages:

Battery powered  
No preheating time

### Weight:

Instrument: 0,42 kg

# FMT

FMT is the unique Foldable Marking Tool for pipes and bends. In less than 5 minutes pipes and bends are marked up for cutting in any particular angle.



Cat. No.	Range mm.	Range inches	Weight (kg)	Weight (lbs)
FMT 1	33 - 90	1,2 - 3,5	2	4
FMT 2	100 - 219	3,9 - 8,6	8	16

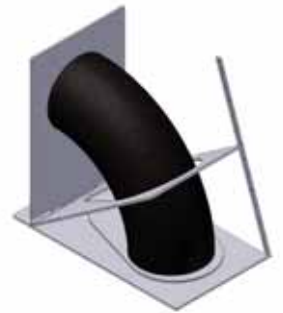

# WT Flange Leveler

WT Flange Leveler is always a good tool to have. The WT Flange Leveler can be used for flanges with bolt holes from 16 mm and larger. With this design you avoid the chance of misplacing loose parts, and you will have no need of using adjusting tools.

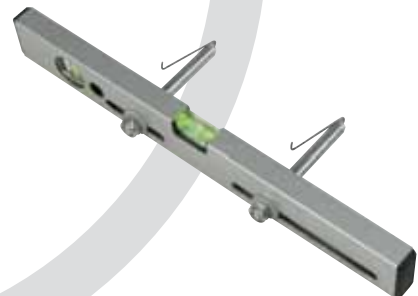
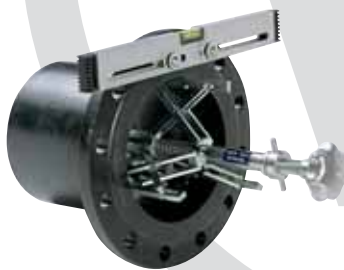

# WT High / Low



The WT High/Low is designed to quickly and accurately measure inside High/Low pipe alignment.

Slæ[, ã^!A{ àP  
U^ã q^!A dæ^F€  
l € €S^} åã \*



V^|ÉI HÁED HG Í FFGH  
T æk ~&O \læ[, ã^!Éæ  
Y^ák, , Éiæ[, ã^!Éæ

# WT Flexi Stand<sup>®</sup>

Max load 6000 kg!

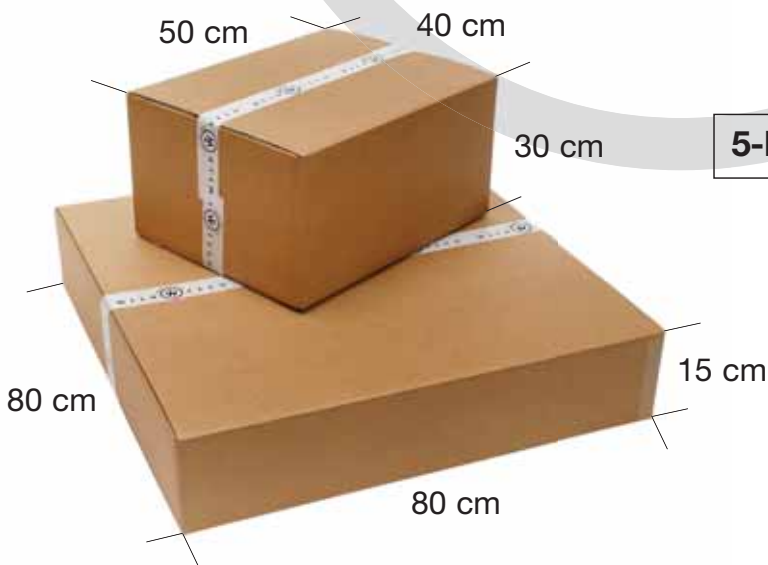
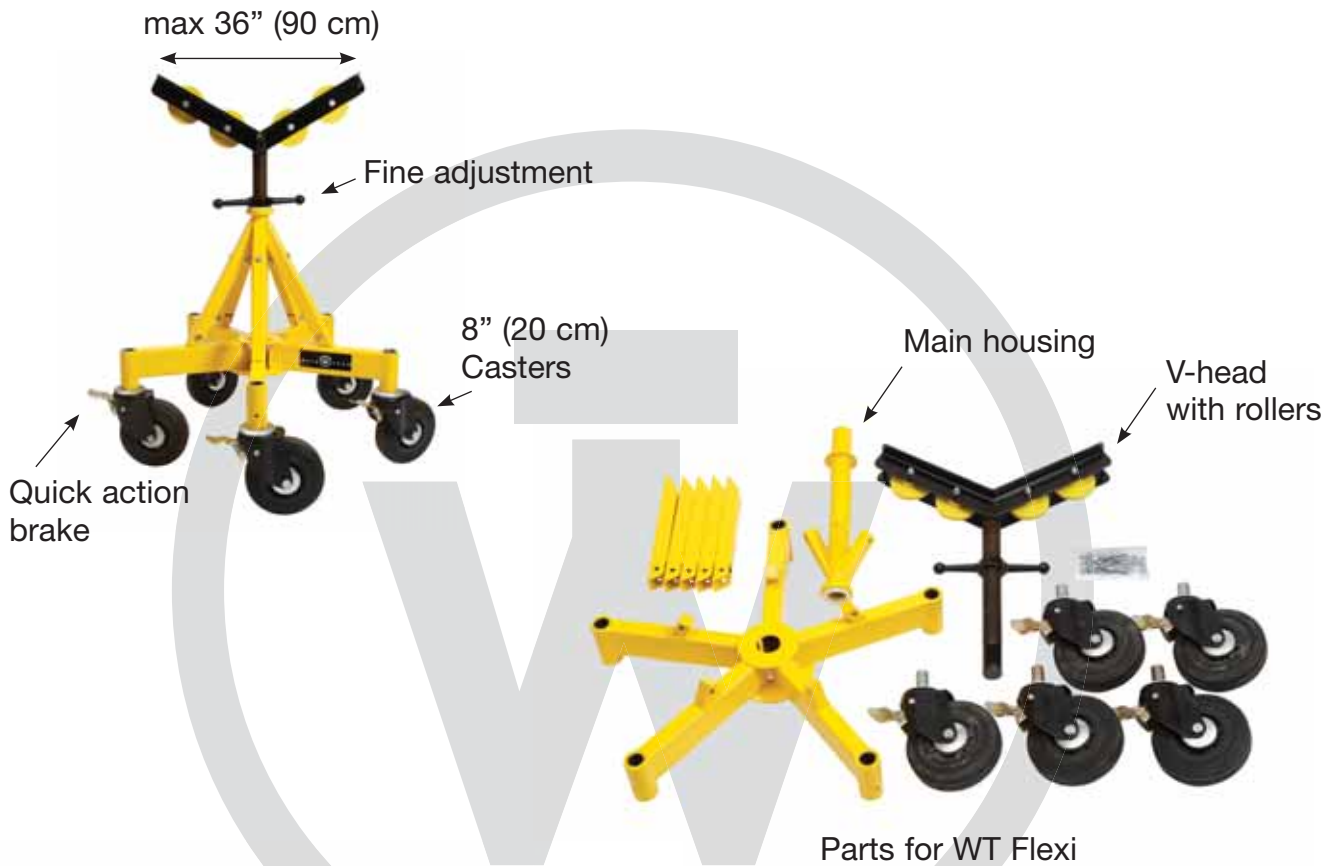

**5-LEG construction for greater stability**

Height		Weight	
Minimum	Maximum	kg	lbs
775 mm	1080 mm	55	123

Slæ[, ã^!A{ àP  
U^ã ò^!A{dæ^A€  
l € €S^}ãä \*



V^|ÉI HÁD HG Í FFGH  
T æk ~&O\|æ[, ã^!Éæ  
Y^ák, , Éiæ[, ã^!Éæ

# WT Fix<sup>®</sup>



## Roller kits:



Stainless steel balls



Steel rollers



Polyethylene rollers



Extensions for use up to 36"

Description	Cat. No.	Capacity		Pipe Size		Weight (1 pc.)	
		kg	lbs	mm	inches	kg	lbs.
Stainless Steel Balls	SSB	925	2.040	12 - 610	1/2 - 24	1,8	3,9
Steel Rollers	SR	450	992	10 - 610	3/8 - 24	1,3	2,8
Polyethylene Rollers	PR	450	992	12 - 610	1/2 - 24	1,1	2,4
Extensions	EXT	450	992	100 - 914	4 - 36	1,7	3,4

Slæ[, ã\!Å{ àP  
U^ã ò^!Aúæ ^Æ  
l € €S^} äã \*



V\|ÉI HÁD HG Í FFGH  
T æk ~&O\|æ[, ã\!Ææ  
Y^ák, , Éæ[, ã\!Ææ



# WT Fold<sup>®</sup> & WT Fix<sup>®</sup>

Max load 1500 kg



Max load  
1500 kg

WT Fold<sup>®</sup>

WT Fix<sup>®</sup>

## Pipe Stands

An new generation of pipe stands has arrived.  
The unique design of the WT Fix and WT Fold is protected by WELD-TECH.

WT Fix and WT Fold are delivered in parts for easier transport – good for the environment – and can be assembled within 5 minutes. Each box includes main housing, V-head and legs including nuts and bolts.

Roller kits are available to any request.

Description	Cat. No.	Weight		Minimum Height		Maximum Height	
		kg	lbs	cm	inches	cm	inches
Pipe Stand, Foldable	WT-Fold	12	26,5	85	33,5	125	49,2
Pipe Stand, Fixed	WT-Fix	11,5	25,4	85	33,5	125	49,2

Slæ[ , ã ^! Å { à P  
U ^ ã ò ^! Å d æ ^ F €  
l € € S ^ } å ã \*



V ^ | É | H á G D H G í F F G H  
T æ k ~ & O \ | æ [ , ã ^! É æ  
Y ^ á k , , É i æ [ , ã ^! É æ

# WT Multi

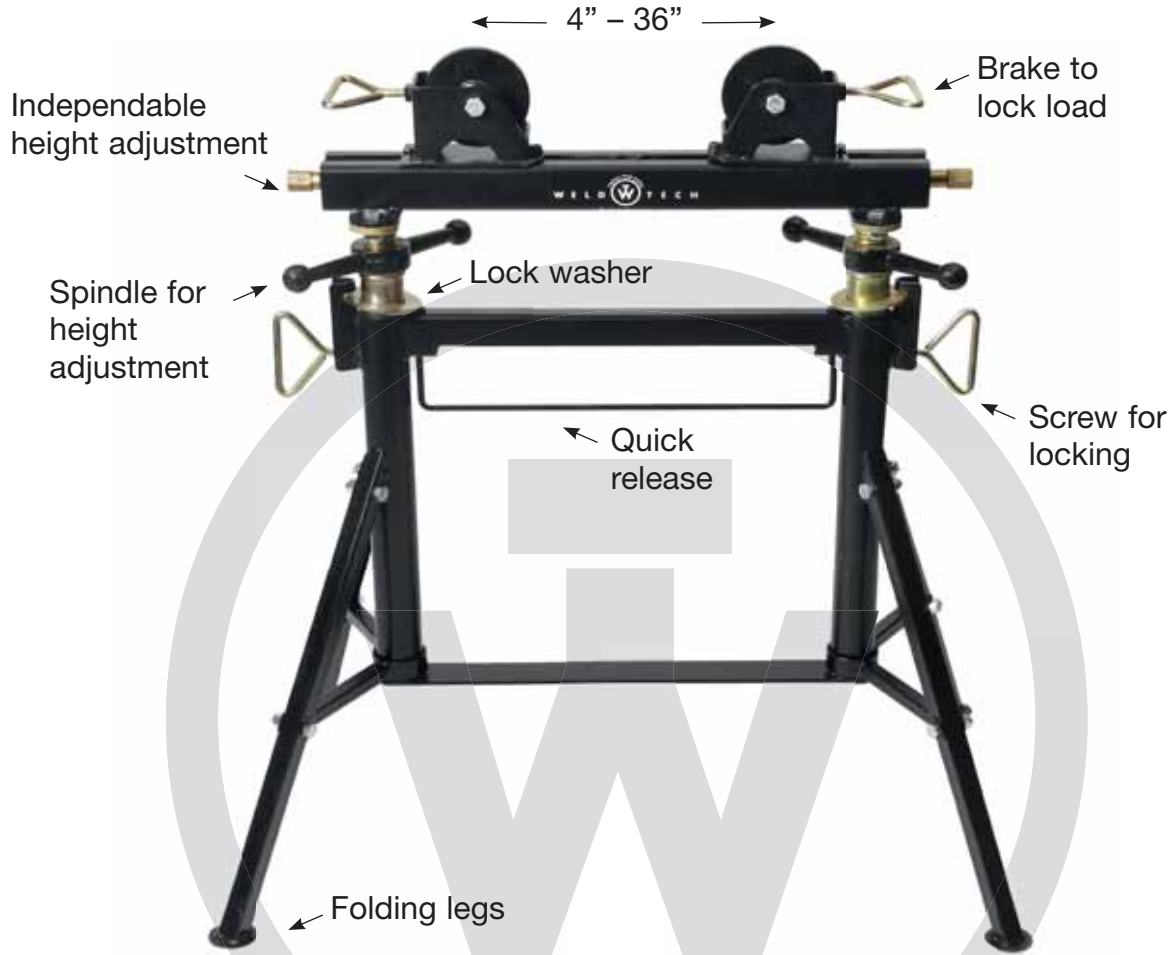

Cat. no	Minimum height	Maximum height	Kg	Lbs
WT Multi	740 mm	1090 mm	28	56

# Floor model Multi Head



Cat. no	Kg	Lbs
Multihead	11	22

Slæ[, ã^!A{ àP  
U^ã ò^!A|dæ^A€  
l€€S^}ãä\*



V^|E|HáG|HG|FFGH  
TæK~&O\|æ[, ã^!Eæ  
Y^ák, , E|æ[, ã^!Eæ